

## 60.2 W SELV Dimmable DALI-2 LED driver

Product code: 5934

60.2 W 220 – 240 V 50 – 60 Hz

- DALI-2 certified LED driver, 1-100 % dimming range
- SELV output protection for safety and flexibility in luminaires
- Low current ripple, complying with IEEE 1789 recommendation
- Amplitude dimming for the highest quality light output
- Current setting via dip-switches
- Ideal solution for Class I and Class II luminaires
- For driving Class III (SELV) luminaires, optional strain relief available for independent use outside of luminaire (LC-SRC)

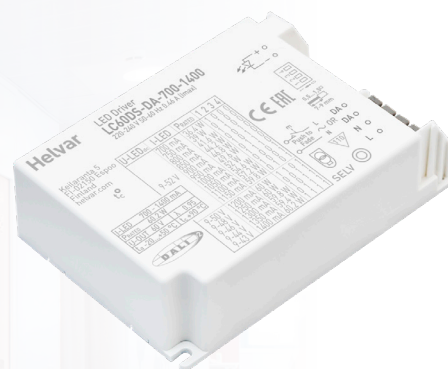

### Functional Description

- Adjustable constant current output: 700 mA to 1400 mA (default)
- Current setting via with dip-switches
- Amplitude dimming technology for the highest quality light in every application
- Suitable for flicker-free camera recording applications
- Optimal fit for EPBD/BREEAM/LEED/WELL due to flicker-free light, energy efficiency and controllability
- Push to Fade functionality for easy-to-use intensity control with smooth fade in transitions
- Potted casing providing additional cover against vibration
- Overload, open & short circuit protection

### Mains Characteristics

Nominal rated voltage range	220 V – 240 V, 50 – 60 Hz
AC voltage range	198 VAC – 264 VAC
	Withstands max. 320 VAC (max. 1 hour)
	Withstands min. 176 VAC (max. 1 hour)
DC voltage range	198 VAC – 280 VDC
Mains current at full load	0.28 – 0.32 A
Frequency	50 Hz – 60 Hz
Stand-by power consumption	< 0.5 W
THD at full power	< 10 %
Tested surge protection	1 kV L-N (IEC 61000-4-5) 2 kV L/N-GND (IEC 61000-4-5)
Tested fast transient protection	4 kV (IEC 61000-4-4)

### Insulation between circuits & driver case

Mains circuit - SELV circuit	Double/reinforced insulation
DALI circuit - SELV circuit	Double/reinforced insulation
Mains circuit - DALI circuit	Basic insulation
Mains, DALI and output - Driver case	Double/reinforced insulation

### Load Output (SELV <60 V)

Output current ( $I_{out}$ )	700 mA – 1400 mA (default)
Accuracy	± 5 %
Ripple	< ±3 %* at ≤ 120 Hz
	*) Low frequency
PstLM	< 0.06*
SVM	< 0.02*
	*) At full power, measured with Cree XP-G LED modules.
$U_{out}$ (max) (abnormal)	60 V

$I_{LED}$	700 mA	1400 mA
$P_{Rated}$	36.4 W	60.2 W
$U_{LED}^*$	9 – 52 V	9 – 43 V
PF ( $\lambda$ ) at full load	0.95	0.95
Efficiency ( $\eta$ ) at full load	88 %	88 %

## Operating window

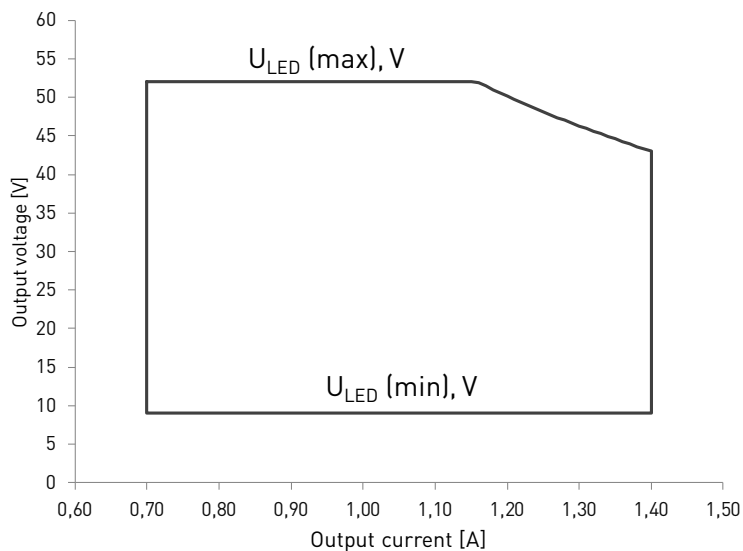

Note: 1) Dimming between 1 - 100 % possible across the operating window, restricted by the absolute minimum dimming current of 10 mA  
 2) Current value is adjustable in steps via dip-switch. See dip-switch settings in page 3 for details.

## Driver performance

Typical efficiency

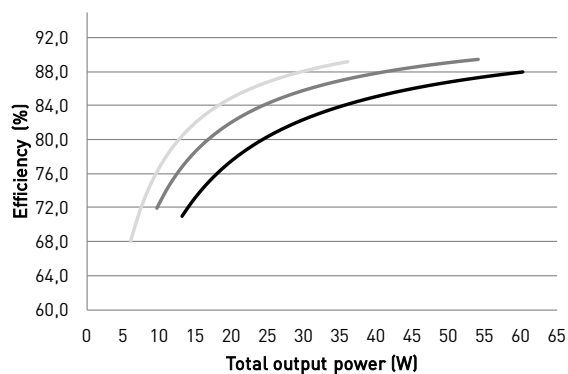

Typical power factor

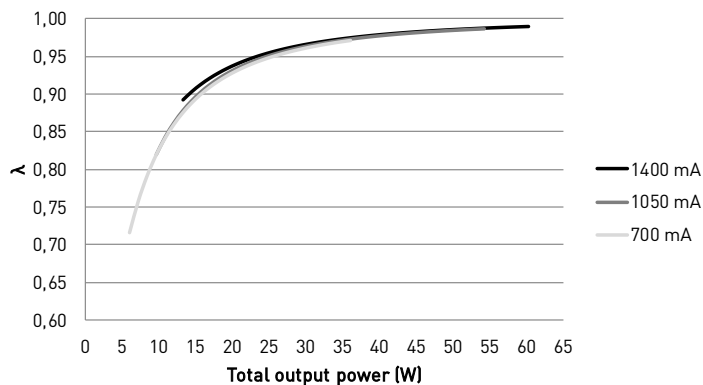

## Operating Conditions and Characteristics

Absolute highest allowed $t_c$ point temperature	90 °C
$T_c$ life (50 000 h) temperature	85 °C
Ambient temperature range	-20 °C ... +50 °C*
Storage temperature range	-40 °C ... +80 °C
Maximum relative humidity	No condensation
Life time (90 % survival rate)	50 000 h, at $t_c = 85$ °C 30 000 h, at $t_c = 90$ °C

\*] For other than independent use, higher  $t_c$  of the controlgear possible as long as highest allowed  $t_c$  point temperature is not exceeded

## Amplitude dimming technology

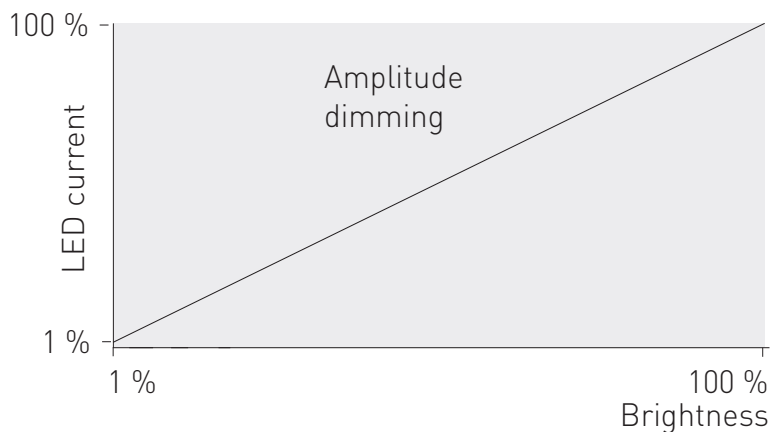

Dimming range	Dimming technology
1 % – 100 %	Amplitude (DC)

LC60DS-DA-700-1400 LED driver implements amplitude dimming technology across whole dimming range. Amplitude dimming offers the best available technology for dimming the light output in an accurate and flicker-free way to ensure high quality lighting in even the most demanding situations such as camera recording applications. Amplitude dimming technology complies with IEEE 1789-2015 recommendations of current modulation to mitigate health risks to viewers.

## Quantity of drivers per miniature circuit breaker 16 A Type C

Based on inrush current $I_{peak}$	Typ. peak inrush current $I_{peak}$	1/2 value time, $\Delta t$
39 pcs	30 A	195 $\mu s$

## CONVERSION TABLE FOR OTHER TYPES OF MINIATURE CIRCUIT BREAKER

MCB type	Relative quantity of LED drivers
B 10 A	37 %
B 16 A	60 %
B 20 A	75 %
C 10 A	62 %
C 16 A	100 % (see table above)
C 20 A	125 %

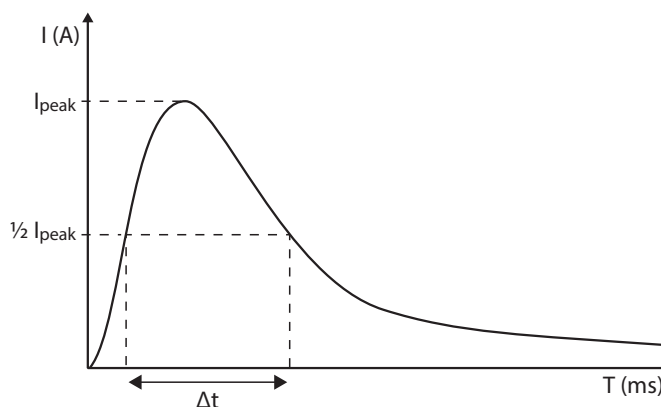

## CONTINUOUS CURRENT

Total continuous current of the drivers and installation environment must always be considered and taken into calculations when installing drivers behind miniature circuit breaker. Example calculation of total drivers amount limited by continuous current:  $n(I_{cont}) = (16 A (I_{nom,Ta}) / \text{“nominal mains current with full load”}) \times 0.76$ . This calculation is an example according to recommended precautions due to multiple adjacent circuit breakers (> 9 MCBs) and installation environment ( $T_a$  30 degrees); variables may vary according to the use case. Both inrush current and continuous current calculations are based on ABB S200 series circuit breakers. More specific information in ABB series S200 circuit breaker documentation.

NOTE! Type C MCB's are strongly recommended to use with LED lighting. Please see more details in "MCB information" document in each driver product page in "downloads & links" section.

## Connections and Mechanical Data

Wire size	0.5 mm <sup>2</sup> – 1.5 mm <sup>2</sup>
Wire type	Solid core and fine-stranded
Wire insulation	According to EN 60598
Maximum driver to LED wire length	1.5 m
Weight	357.3 g
IP rating	IP20

## Connections

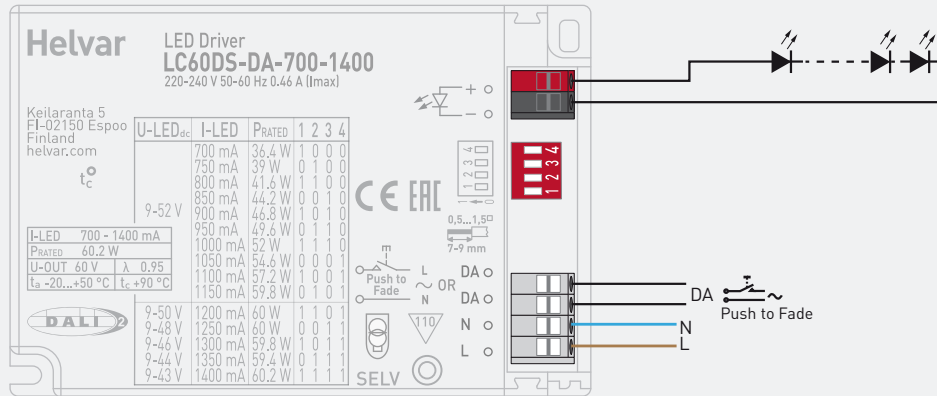

Note:

- Not suitable for load side switching operation

## Dimensions (mm)

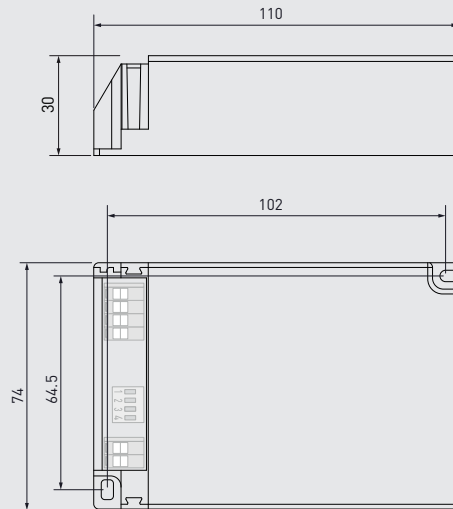

In LC60DS-DA-700-1400, the current can be set with dip-switches. With each combination of switch setup, a different output current value can be set. The maximum value can be reached with the all dip-switches set to "1" (pushed towards to the label, see connections picture above) and minimum with all switches set to "0". The output current values according to the dip-switch settings are presented below.

## Dip-switch combinations, output currents and voltage ranges (Nominal I<sub>out</sub> (±5 % tol.))

Dip-Switch combination	1111	0111	1011	0011	1101	0101	1001	0001
I <sub>out</sub> (mA)	1400	1350	1300	1250	1200	1150	1100	1050
Voltage range	9 - 43 V	9 - 44 V	9 - 46 V	9 - 48 V	9 - 50 V	9 - 52 V	9 - 52 V	9 - 52 V
Dip-Switch combination	1110	0110	1010	0010	1100	0100	1000	-
I <sub>out</sub> (mA)	1000	950	900	850	800	750	700	-
Voltage range	9 - 52 V	9 - 52 V	9 - 52 V	9 - 52 V	9 - 52 V	9 - 52 V	9 - 52 V	.

LC60DS-DA-700-1400 LED driver is suited for built-in usage in luminaires. With external strain relief (LC-SRC) independent use is possible too. In order to have safe and reliable LED driver operation, the LED luminaires will need to comply with the relevant standards and regulations (e.g. IEC/EN 60598-1). The LED luminaire shall be designed to adequately protect the LED driver from dust, moisture and pollution. The luminaire manufacturer is responsible for the correct choice and installation of the LED drivers according to the application and product datasheets. Operating conditions of the LED drivers may never exceed the specifications as per the product datasheet.

## Installation & operation

### Maximum ambient and $t_c$ temperature:

- For built-in components inside luminaires, the  $t_a$  ambient temperature range is a guideline given for the optimum operating environment. However, integrator must always ensure proper thermal management (i.e. mounting base of the driver, air flow etc.) so that the  $t_c$  point temperature does not exceed the  $t_c$  maximum limit in any circumstance.
- Reliable operation and lifetime is only guaranteed if the maximum  $t_c$  point temperature is not exceeded under the conditions of use.

### Current setting via dip-switch

LC60DS-DA-700-1400 LED driver features a constant current output adjustable via Dip-switch combinations

- For the combination/current values, refer to the table on page 4.

### Miniature Circuit Breakers (MCB)

- Type-C MCB's with trip characteristics in according to EN 60898 are recommended.
- Please see more details in "MCB information" document in each driver product page in "downloads & links" section.

### Installation site

- The general preferred installation position of LED drivers for independent use is to have the top cover facing upwards.

## Lamp failure functionality

### No load

When open load is detected, driver goes to standby and recovers through mains reset.

### Overload

When overload is detected, driver goes to standby mode and recover after mains reset.

### Short circuit

Driver can withstand output short circuit and after resolving the fault, driver recovers after mains reset.

## Push to Fade

Push to Fade solution includes additional fading behavior, which provides smooth transition between on and off states. Please note that Push to Fade is not compatible to be installed in the same circuit with Helvar Switch-Control or Switch-Control 2 devices.

Always before installation and for troubleshoot and guidance, refer to the user guide at [www.helvar.com](http://www.helvar.com).

### Use of Push to Fade functionality

- Maximum numbers of LED drivers to be connected to one switch is 30.
- Ensure that all components connected to Push to Fade circuitry are mains rated.
- The transition between 0 to 100% (when turned ON / OFF) is ~ 1 second.

## Conformity & standards

General and safety requirements	EN 61347-1: 2015
Particular safety requirements for DC or AC supplied electronic control gear for LED modules	EN 61347-2-13: 2014 + A1: 2017
Thermal protection class	EN 61347, C5e
Mains current harmonics	EN 61000-3-2: 2014
Limits for voltage fluctuations and flicker	EN 61000-3-3: 2013
Radio frequency interference	EN 55015: 2013
Immunity standard	EN 61547: 2009
Performance requirements	EN 62384: 2006+ A1:2009
<b>Digital addressing lighting interface:</b>	
General requirements for DALI system	EN 62386-101 (DALI-2)
Requirements for DALI control gear	EN 62386-102 (DALI-2)
Requirements for control gear of LED modules (DALI Device Type 6)	EN 62386-207 (DALI-2)
Recommended Practices for Modulating Current in High-Brightness LEDs for Mitigating Health Risks to Viewers	IEEE 1789-2015
Compliant with relevant EU directives	
RoHS/REACH compliant	
CE marked	

## Label symbols



Safety isolating control gear with short circuit protection (SELV control gear).



Double insulated control gear suitable for built-in use.



Thermally controlled control gear, incorporating means of protection against overheating to prevent the case temperature under any conditions of use from exceeding 110 °C.



DALI-2 certified control gear.